



BASKILI SACLAR
DELİKLİ SACLAR
GENİŞLETİLMİŞ METALLER
DEKORATİF SACLAR



doğın

www.doganmetal.com.tr

ÜRÜN KATALOĐU

DBS - 1010 Yeni Baklava

Ebat	1000 x 2000
Kalınlık	0.5 - 1.5 mm



DBS - 1020 Lale

Ebat	1000 x 2000
Kalınlık	0.5 - 1.5 mm



DBS - 1030 Kristal

Ebat	1000 x 2000
Kalınlık	0.5 - 1.5 mm

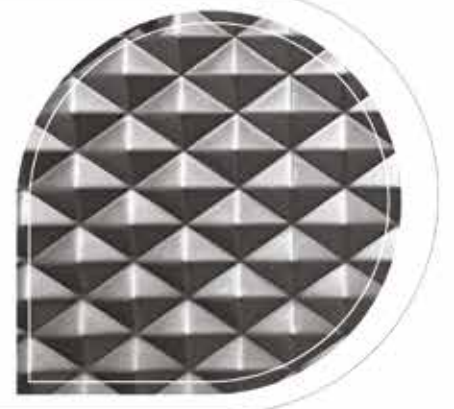

DBS - 1040 Sarmaşık

Ebat	1000 x 2000
Kalınlık	0.5 - 1.5 mm



DBS - 1050**Güneş (Ayçiçeği)**

Ebat	750 x 2000	850 x 2000	1000 x 2000
Kalınlık	0.5 - 1.5 mm		

**DBS - 1060****Sepet Örgü**

Ebat	1000 x 2000		
Kalınlık	0.5 - 1.5 mm		

**DBS - 1070****Yeni Piramit**

Ebat	1000 x 2000		
Kalınlık	0.5 - 1.5 mm		

**DBS - 1080****Küçük Piramit**

Ebat	750 x 2000	850 x 2000	1000 x 2000
Kalınlık	0.5 - 1.5 mm		



DDS -1000

Yuvarlak

Ebat	Standart ebat ve özel ebat üretimi
Kalınlık	0.5 - 5 mm
Delik Çapı	Ø2 - Ø20 mm arası

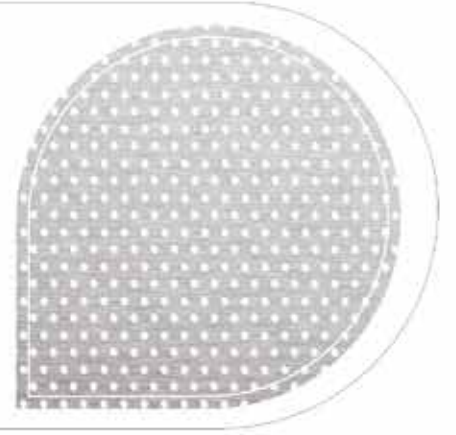

DDS -2000

Üçgen

Ebat	Standart ebat ve özel ebat üretimi
Kalınlık	0.5 - 5 mm

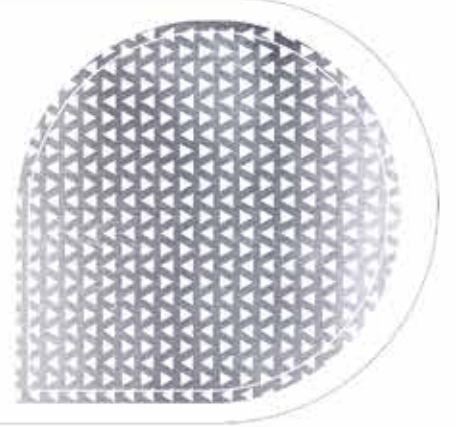

DDS -3000

Kare

Ebat	Standart ebat ve özel ebat üretimi
Kalınlık	0.5 - 5 mm

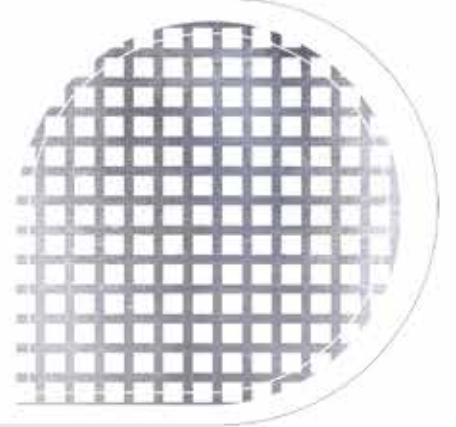

DDS -4000

Slot

Ebat	Standart ebat ve özel ebat üretimi
Kalınlık	0.5 - 5 mm



DDS -5000

Patlatma

Ebat	Standart ebat ve özel ebat üretimi
Kalınlık	0.5 - 5 mm

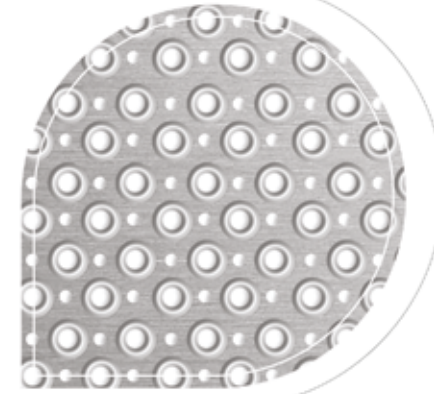

DDS -6000

Panjur Sacı

Ebat	Standart ebat ve özel ebat üretimi
Kalınlık	0.5 - 3 mm

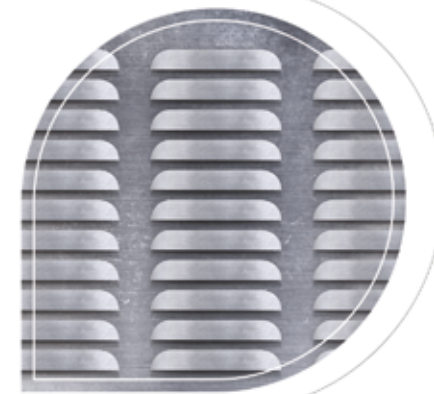

DGB -2010

Ebat	Standart ebat ve özel ebat üretimi
Kalınlık	0.5 - 3 mm

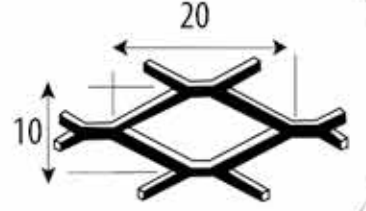
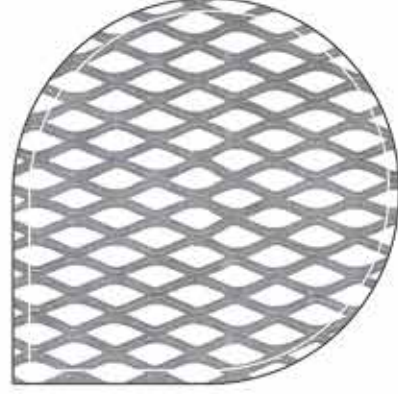

DGB -3013

Ebat	Standart ebat ve özel ebat üretimi
Kalınlık	0.5 - 3 mm

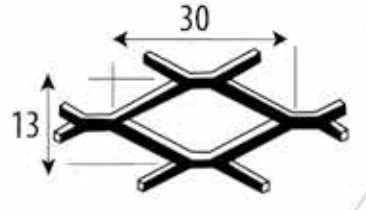
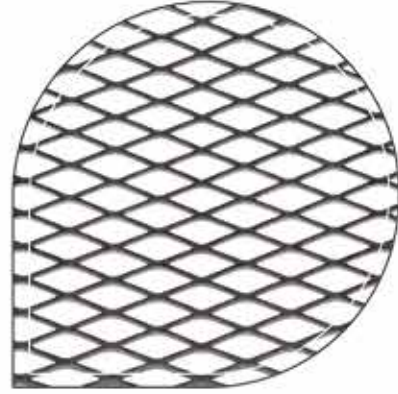

DGB -4018

Ebat	Standart ebat ve özel ebat üretimi
Kalınlık	0.8 - 4 mm

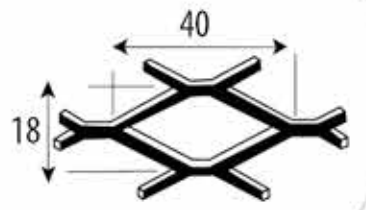
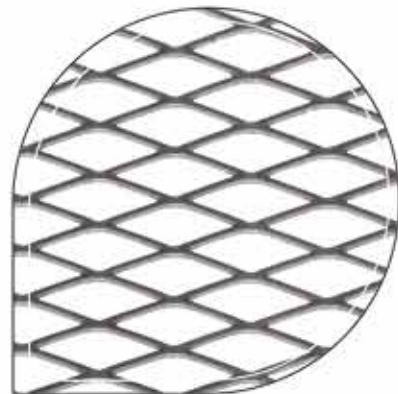

DGB -5018

Ebat	Standart ebat ve özel ebat üretimi
Kalınlık	1 - 5 mm

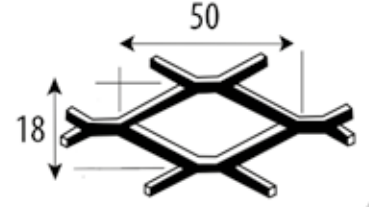
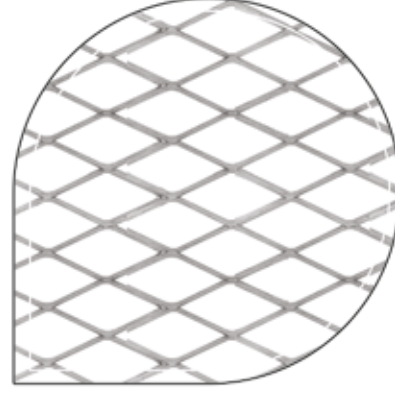

DGB -6022

Ebat	Standart ebat ve özel ebat üretimi
Kalınlık	1 - 5 mm

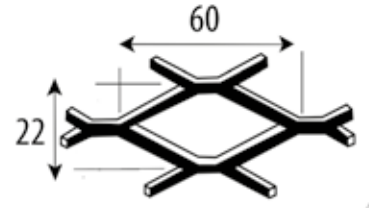
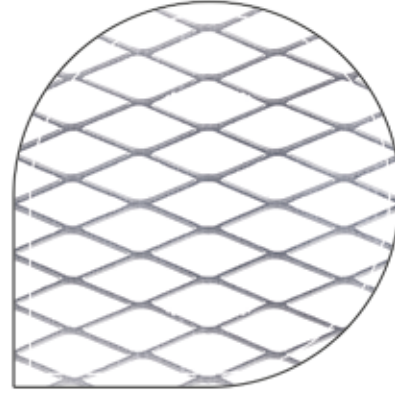

DGB -4525 *Balpeteği*

Ebat	Standart ebat ve özel ebat üretimi
Kalınlık	0.5 - 1.5 mm

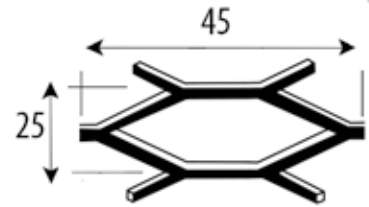
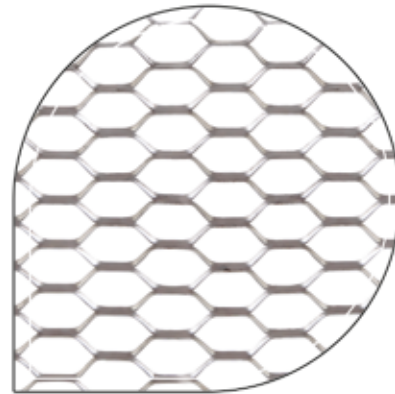

DGB -8030

Ebat	Standart ebat ve özel ebat üretimi
Kalınlık	1 - 5 mm

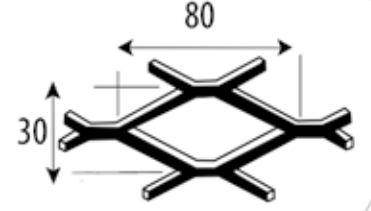
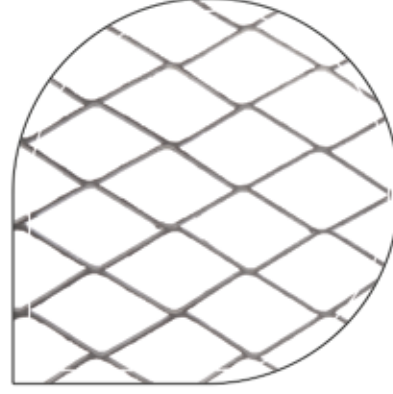
**DGB -8030** *Balpeteği*

Ebat	Standart ebat ve özel ebat üretimi
Kalınlık	1 - 5 mm

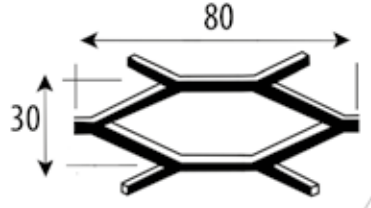
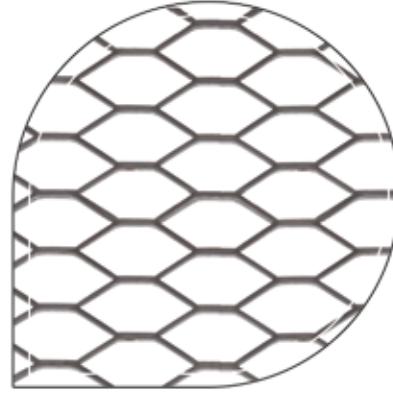
**DGB -11540**

Ebat	Standart ebat ve özel ebat üretimi
Kalınlık	1.5 - 5 mm

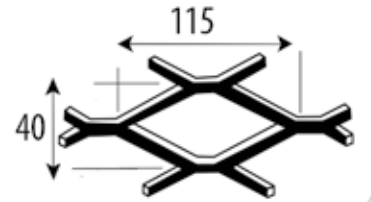
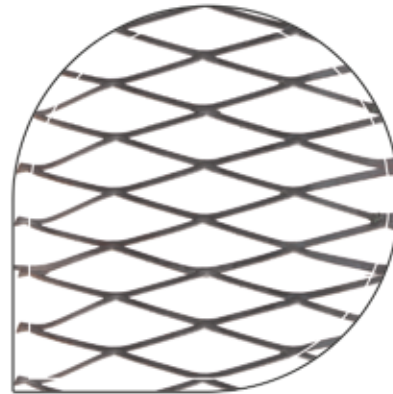

DGB -15070

Ebat	Standart ebat ve özel ebat üretimi
Kalınlık	1 - 5 mm

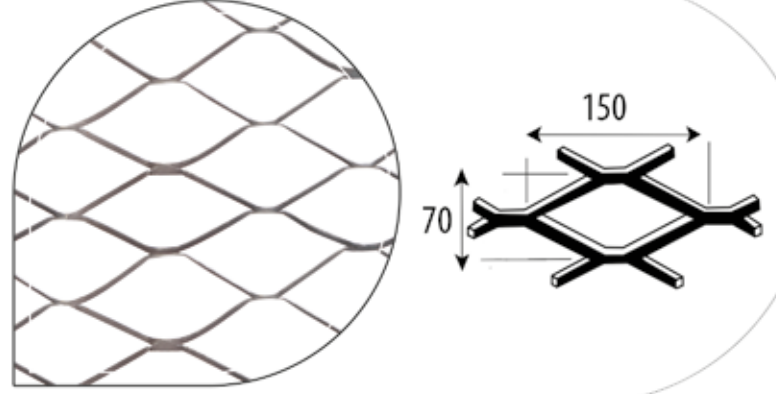

DGB -8013

Küçük Kare Kristal

Ebat	Standart ebat ve özel ebat üretimi
Kalınlık	1 - 3 mm

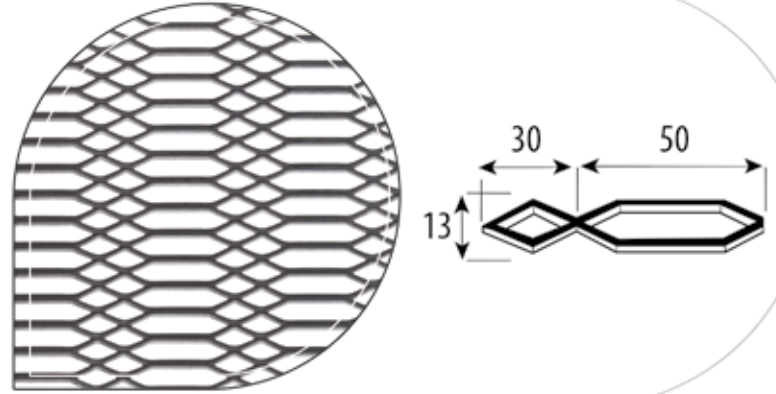

DGB -13018

Büyük Kare Kristal

Ebat	Standart ebat ve özel ebat üretimi
Kalınlık	1 - 3 mm

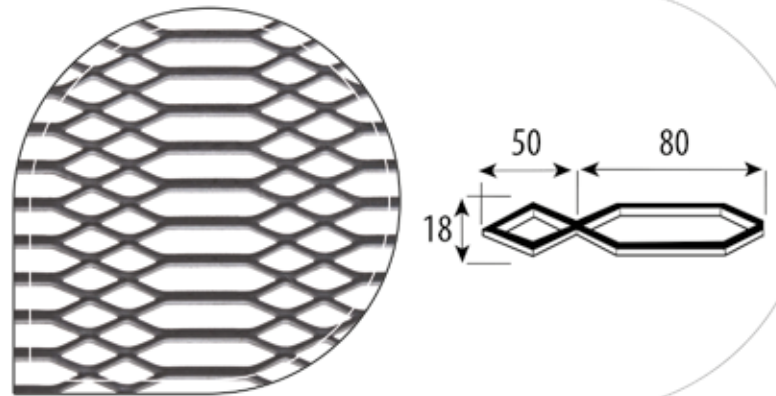

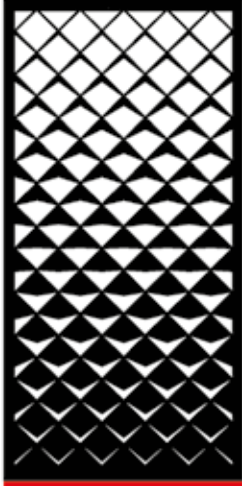

DLS - 0010
100 x 200



DLS - 0020
100 x 200

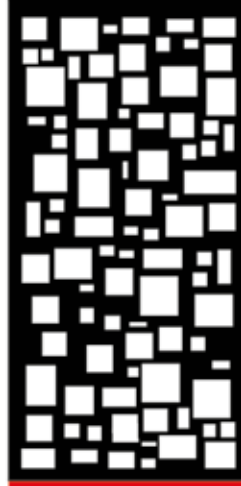

DLS - 0030
100 x 200



DLS - 0040
100 x 200

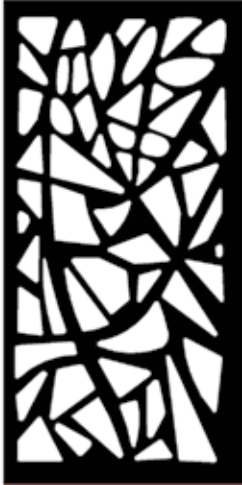

DLS - 0050
100 x 200



DLS - 0060
100 x 200



DLS - 0070
100 x 200

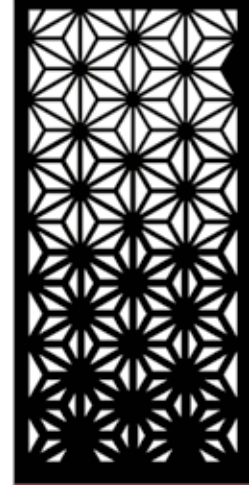

DLS - 0080
100 x 200



DLS - 0090
100 x 200



DLS - 0100
100 x 200



DLS - 0110
100 x 200

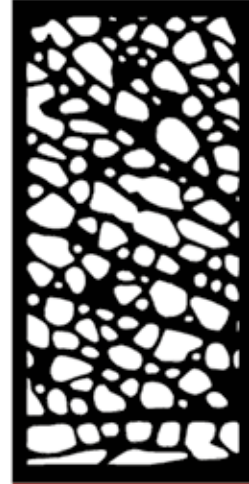

DLS - 0120
100 x 200

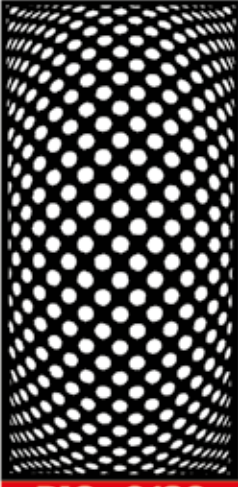

DLS - 0130

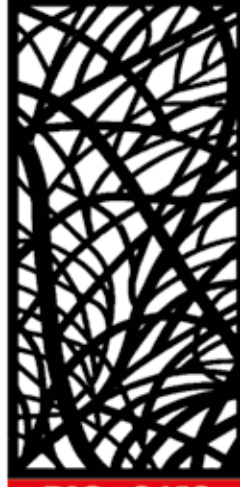

DLS - 0140



DLS - 0150



DLS - 0160



DLS - 0170



DLS - 0180



DLS - 0190

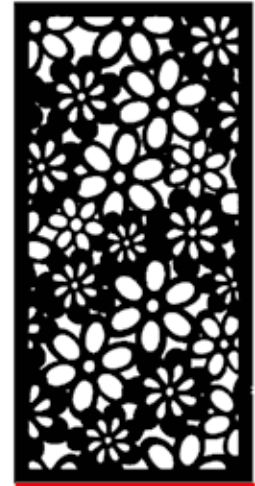

DLS - 0200

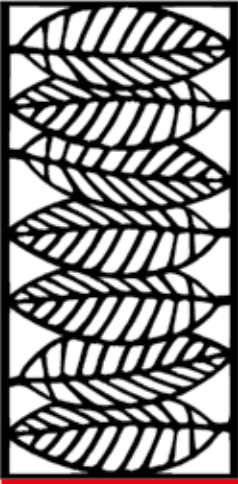

DLS - 0210



DLS - 0220



DLS - 0230

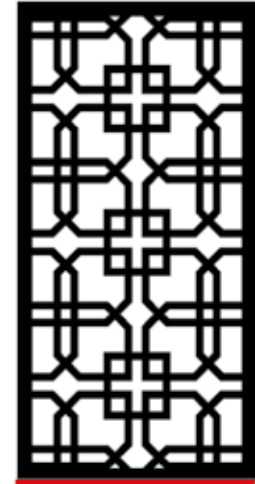

DLS - 0240



Büsan Organize Sanayi Bölgesi 8. Sokak No:7 Karatay / KONYA
0332 345 25 25 (Pbx) genisletilmis@doganmetal.com.tr



Büsan Organize Sanayi Bölgesi 3. Sokak No:21
Karatay / KONYA
0332 345 15 15 - info@doganmetal.com.tr



Fevzi Çakmak Mahallesi Aslım Caddesi No:53/P
Karatay / KONYA
0332 248 48 48 - info@dogansaclazer.com

doğan metal grubu

0332 345 25 25

www.doganmetal.com.tr